

Molteni & C

505 — NICOLA GALLIZIA 2016

1—
14



505, Molteni&C's key modular system, has been radically upgraded to offer furnishing systems in tune with contemporary living. The main innovations are the introduction of a new type of reinforced surface, which uses a light composite material inside: reticulated PVC foam, used to make wind turbine blades. Light but structurally extremely rugged, it enables very broad surfaces (of up to 186cm) to be made, without the need for supporting partitions. Partitions are anyway used to subdivide the spaces with the particularity of being positionable at will within the framework. New tops up to 54cm deep 7,2cm thick, allow for work tops of up to 377cm fully integrated in the composition or on their own. These can turn into desks, open or closed compartments, for book rests and objects to be displayed or stored. Discreet mechanisms allow for tip-up doors and multi-purpose roll-tops. The finishes have been enriched too, with graphite oak, a fine tactile surface with an unusual color.

DATASHEET

REGISTERED
DESIGN

VII.2016

molteni.it

Dimensions in millimeters and inches. The right to discontinue and make changes is reserved. This information is based on the latest product information available at the time of printing.

MODULARITY

Measurements

Wall to wall widths:

315 - 473 - 630 - 945 - 1260 - 1417 - 1890 + 28 mm for end piece
12 3/8" - 18 5/8" - 24 7/8" - 37 1/4" - 49 5/8" - 55 3/4" - 74 3/8" + 1 1/8"

Heights:

397 - 717 - 1037 - 1357 - 1677 - 1997 - 2317 - 2637 - 2957 mm
15 5/8" - 28 1/4" - 40 7/8" - 53 3/8" - 66" - 78 5/8" - 91 1/4" - 103 7/8" - 116 3/8"

Structure depth:

304 - 400 - 540 mm (12" - 15 3/4" - 21 1/4")

Depth with pressure opening th 40 (1 5/8") / glass doors with shaped profile:

348 - 444 - 584 mm (13 3/4" - 17 1/2" - 23")

Depth with pressure opening or handle th 22 (7/8"):

330 - 426 - 566 mm (13" - 16 3/4" - 22 1/4")

Notes

A minimum extra height space of 30 mm (1 1/8") is required for installation purposes; the same applies for the width if placed in a niche. Width, height, depth reductions are made with an interval of 32 mm (1 1/4"), the costs will be charged to the Customer.

The minimum width is 315 mm (12 3/8"), therefore no reductions is forseen for units of 315 mm (12 3/8").

**No reduction possible for:
Internal and external drawers**

Sliding doors

Glass hinged doors

Vertical sliding doors

Flap doors th 40 (1 5/8")

Hinged doors th 40 (1 5/8")

TV compartment D 400 (15 3/4")

Modules W 1417 (55 3/4") and 1890 (74 3/8") in width and depth

Heights and depth of the units resting on the floor

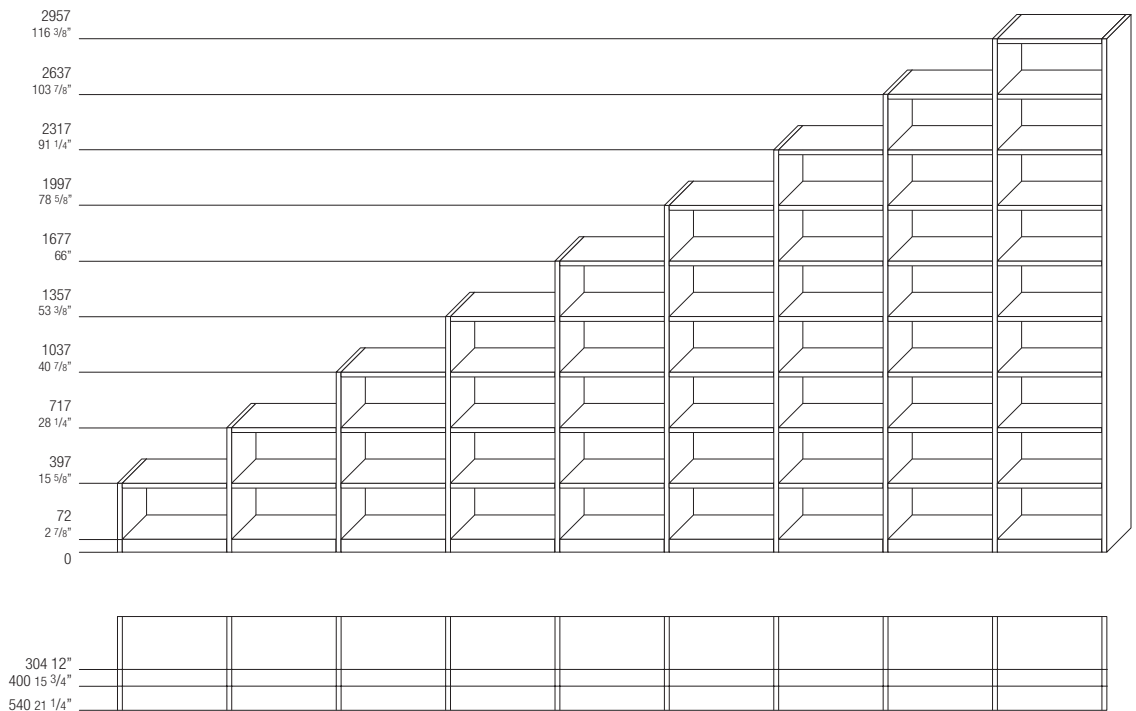

DATASHEET

REGISTERED
DESIGN

VII.2016

FINISHES

Wood grain

Pressure opening th 40

- HORIZONTAL GRAIN for vertical sliding doors, drawers and flap doors
- HORIZONTAL AND VERTICAL GRAIN for hinged and sliding doors

Pressure opening th 22

- HORIZONTAL GRAIN for drawers
- VERTICAL GRAIN for hinged doors

Handle opening th. 22

- HORIZONTAL GRAIN for drawers
- VERTICAL GRAIN for hinged doors

Handle

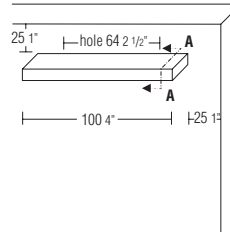

type B

handle opening th 22 (7/8")
(always horizontally positioned).
Upon request can be mounted on a vertical sliding door

section A-A

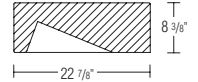

finishes:

- shiny chrome
- black chrome
- pewter colour

Molteni & C

finishes		matt lacquer colours	glossy lacquer colours	woods	special woods	transparent glass	coloured glass	coloured etched glass	shiny aluminium/black chrome/pewter colour	Eco Skin	stopsoil glass
components											
structure and plinth											
mobile partitions										"L-shaped"	
backs											
rear finishing panels											
internal drawer units											
door opening th. 40 (hinged/sliding/flap/vertical sliding)											
doors/external drawers with handle or pressure opening th. 22											
glass doors with shaped profile (hinged/sliding/vertical sliding)	trims										
	glass					hinged	sliding	sliding			vertical sliding/hinged
shelves											
tops											
protruding shelves D 540											
backs for TV											

colours

Matt lacquer

BC chalk white
AV ivory
PE pearl
DN dune
PL platinum
PB lead
NE black
AT anthracite
SE mustard
SI silica
DO dolomite grey
AL clay
MK moka
CM caramel
CZ light blue grey
SA sand
RU ruby
CI cadmium
VB baltic green

Glossy lacquer

BC chalk white
PE pearl
DN dune
PL platinum
PB lead
NE black
AT anthracite
SE mustard
SI silica
DO dolomite grey
AL clay
MK moka
CM caramel
CZ light blue grey
SA sand
RU ruby
CI cadmium
VB baltic green

Woods

EU eucalyptus
RG grey oak
RF graphite oak

Special woods

OC light elm
OS dark elm

Coloured glass

BC chalk white
PE pearl
DN dune
PL platinum
PB lead
NE black
AT anthracite
SE mustard
SI silica
DO dolomite grey
AL clay
MK moka
CM caramel
CZ light blue grey
SA sand
RU ruby
CI cadmium
VB baltic green

Coloured etched glass

BC chalk white
PE pearl
DN dune
PL platinum
PB lead
NE black
AT anthracite
SE mustard
SI silica
DO dolomite grey
AL clay
MK moka
CM caramel
CZ light blue grey
SA sand
RU ruby
CI cadmium
VB baltic green

Eco Skin

grey
mink
hemp
ivory
dark brown

DATASHEET

REGISTERED
DESIGN

VII.2016

molteni.it

Dimensions in millimeters and inches. The right to discontinue and make changes is reserved. This information is based on the latest product information available at the time of printing.

TECHNICAL INFORMATION

SIDES, SHELVES TH. 28, BACKS, TV BACKS

Chipboard covered with Oak (Quercus), Eucalyptus (Eucalyptus globulus) or melamine painted in colours from the Molteni range.

ALUMINIUM/REINFORCED SHELF

Composite panel with internal frame in wood particles, filler in the structural PVC foam and 1mm aluminium sheet, covered in wood veneer in Eucalyptus or Oak, or melamine facing painted in Molteni Range colours. For panels 1231 in width, the panel is in honeycomb with internal reinforcement bars in iron.

BASEBOARD

Anodised extruded aluminium painted in colours from the Molteni range or covered with Oak or Eucalyptus.

WOODEN DOORS TH. 22 AND EXTERNAL DRAWER FRONT TH. 22

Chipboard covered with Oak, Elm (Ulmus rubra), Eucalyptus or melamine painted in colours from the Molteni Range.

DOOR AND DRAWER FRONT TH. 40

Honeycomb or chipboard panel covered with wood veneer in Oak, Elm or Eucalyptus, or melamine facing painted in Molteni Range colours.

GLASS DOORS WITH SHAPED PROFILE

Frame in extruded anodised aluminium. Tempered glass th. 5mm in Molteni range finishes.

PROTRUDING SHELF

Chipboard panel covered in wood veneer in Eucalyptus or Oak, or with Eco Skin in Molteni Range colours. Perimeter profile in extruded aluminium painted in Molteni Range colours. If used out of composition, the shelf has metal brackets for fastening to the wall.

DIVIDERS

Chipboard panel in box-structure wood covered in wood veneer in Eucalyptus or Oak, or melamine facing painted in Molteni Range colours, or in artificial leather in Molteni Range colours. Caps in moulded plastic with coextruded rubber profiles.

WOODEN TOP TH. 10

MDF covered with Oak, Elm, Eucalyptus sliced wood or melamine covered, painted in colours from the Molteni Range.

GLASS TOP TH. 10

Tempered glass th. 10mm painted in Molteni Range colours.

INSIDE DRAWER BOTTOM AND SIDES

Chipboard covered with melamine.

HANDLES AND WIRE HOLE

In several materials and finishes available.

GLASS SHELVES

8 mm thick tempered clear crystal.

LADDER

Painted aluminium.

SLIDING DOOR TRACK, BRIDGE BAR

Anodised extruded aluminium (several finishes).

TECHNICAL INFORMATION

Molteni & C

5—
14

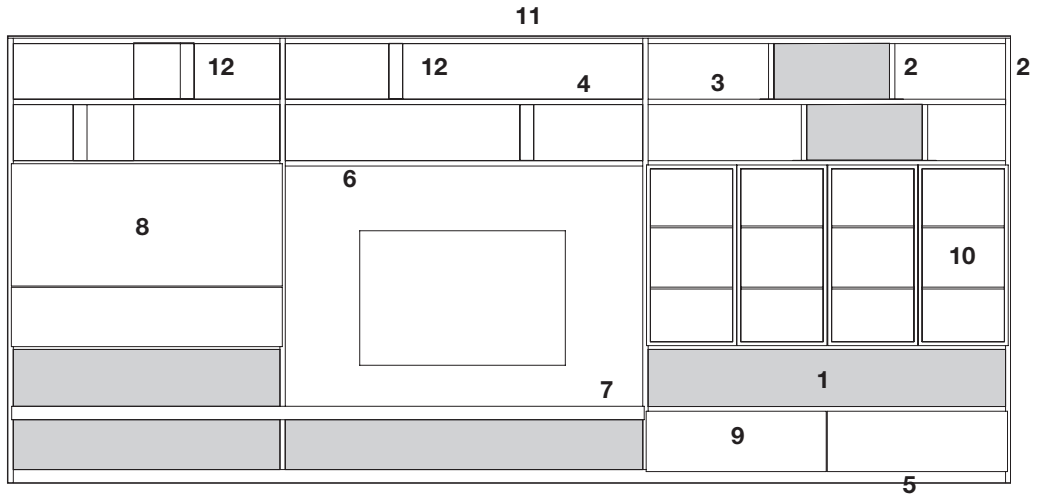

- 1** Back
- 2** Lateral piece
- 3** Shelf
- 4** Aluminium/reinforced shelf
- 5** Plinth or sliding track
- 6** Bridge bar
- 7** Protruding shelf D 540
- 8** Doors and fronts th. 40
- 9** Doors and fronts th. 22
- 10** Glass doors
- 11** Top th. 10
- 12** Dividers

HINGE ADJUSTMENT

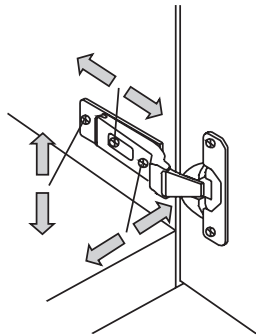

HINGE ADJUSTMENT
GLASS DOORS

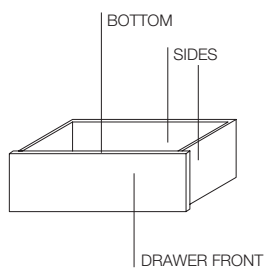
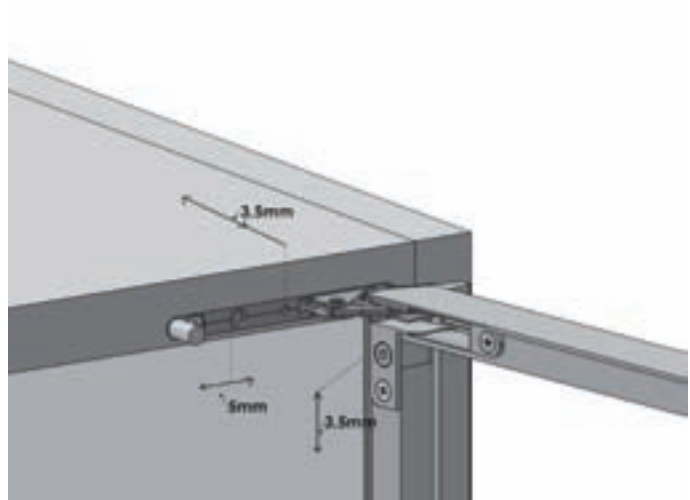

DATASHEET

REGISTERED
DESIGN

VII.2016

molteni.it

Dimensions in millimeters and inches. The right to discontinue and make changes is reserved. This information is based on the latest product information available at the time of printing.

OPEN CORNER COMPOSITIONS

Internal corner

Features

To create the compositions described here, it is obligatory to use central partition dividers (D 304 - 12") positioned so that the width of the internal compartment does not exceed mm 916 (centre distance 945), and also that the partitions near the joints be positioned as indicated in the options (*). Tops with thickness 28 must not be in aluminium. To calculate the price of the plinths, please note that the length is the same as the base. For dual-faced compositions the price of the plinth has to be calculated twice and also the price of one ZO/04 has to be added. These corner compositions are only available in the depth of 400 (15 3/4").

The sections between the two compulsory central partitions cannot be closed by any kind of fronts and are always without back panels.

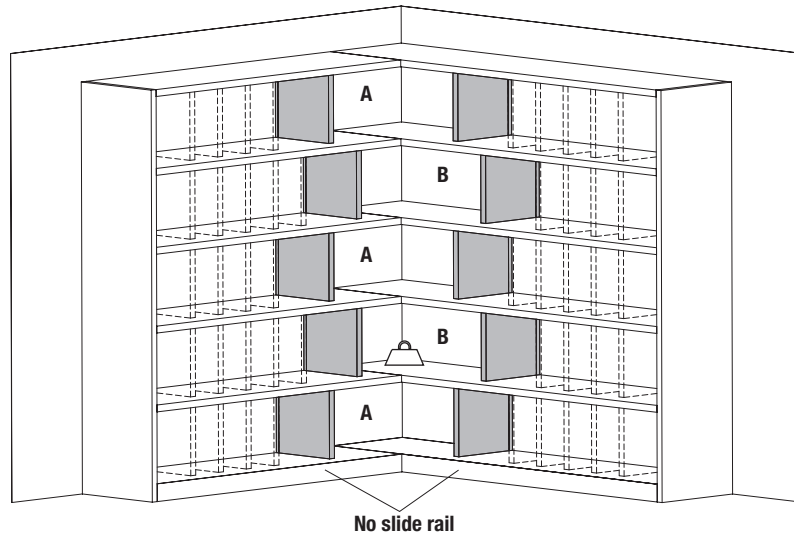



The section between the two mandatory central partitions has a load capacity of 10 Kg, evenly distributed

External corner

Features

To create the compositions described here, it is obligatory to use central partition dividers (D 304 - 12") positioned so that the width of the internal compartment does not exceed mm 916 (centre distance 945), and also that the partitions near the joints be positioned as indicated in the options (*). Tops with thickness 28 must not be in aluminium. The price of one ZO/04 for completing the corner has to be added to the price of the plinths. To calculate the price of the plinths, please note that the length is the same as the base, by dual-faced composition, the price of the plinth has to be calculated twice. These corner compositions are only available in the depth of 400 (15 3/4").

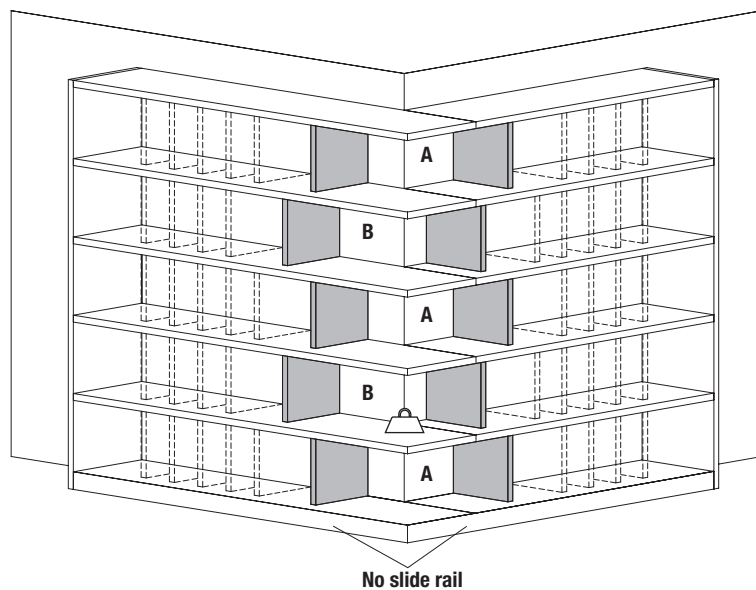
The sections between the two compulsory central partitions cannot be closed by any kind of fronts and are always without back panels.



The section between the two mandatory central partitions has a load capacity of 10 Kg, evenly distributed

DATASHEET

REGISTERED
DESIGN

VII.2016

molteni.it

Dimensions in millimeters and inches. The right to discontinue and make changes is reserved. This information is based on the latest product information available at the time of printing.

INTERNAL DRAWER UNITS

Internal drawer units - For open compartments, sliding doors, hinged glass doors with shaped profile and hinged wooden doors th 22 with pressure opening mechanism and with handle

The internal drawer units can be positioned between two shelves th. 28 mm (example **A**).
For units with glass doors, W 1417 and 1890, the central divider **SPD4/03** (example **B**) must be inserted between the two aluminium shelves.

All drawers are always with pressure opening and always fully extractable.

If the compartments are open, or closed by a sliding door, the drawer unit is flush with the structure. When the internal drawer units are behind a glass hinged door they are recessed of 18 mm (3/4") and aligned with the internal shelves.

The compartment that holds the internal drawer unit must always have a back panel or a rear finishing panel.

Molteni & C

Example A

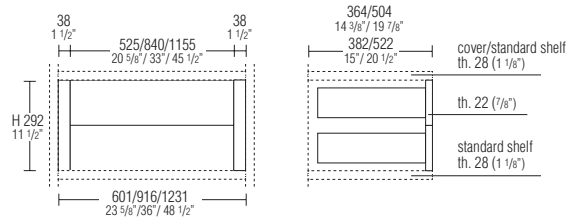

Example B

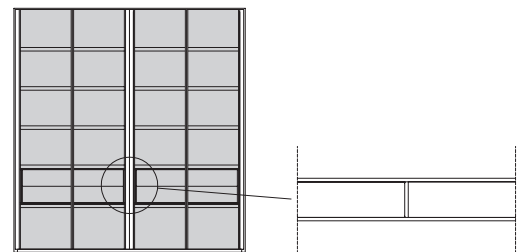

HI-FI COMPARTMENT D 400 (SINGLE PANEL)

By using module widths 1260-1417-1890 TV units can be formed. TV units are always fitted with a removable rear panel, on which the TV can be hung. For wall-mounted TV, the wiring hole on the back is the client's responsibility. The back panel is fixed from the front. For the bridge unit the bar is mandatory even if it is wall-mounted or the unit is suspended.

The back is shorter than the Hi-Fi compartment height for the passage of cables, (see details A and B).

TV signal receiver

The \varnothing 18 sensor is always positioned in the lower part of the TV back. Specify right or left when ordering. IR bars can only be placed in a compartment adjacent or below the TV back (to be specified when ordering). The cost of a wire passage is not included. The bar can only be fixed to the structural panels.

Wire passage

The Hi-Fi compartment may be connected using a wire passage to adjacent or lower compartments. The wire passage is located behind the TV back.

Molteni & C

8 —
14

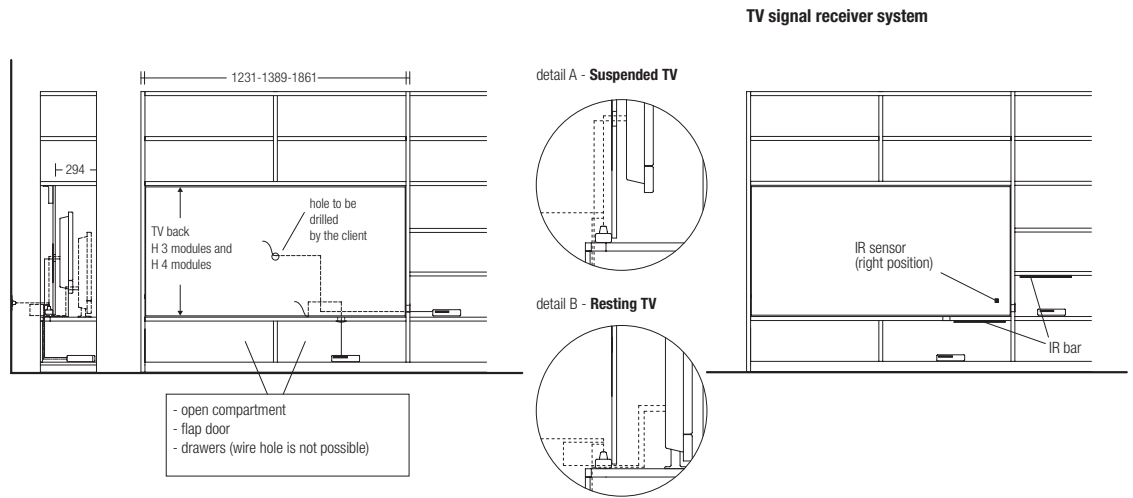

Hi-Fi compartment on base

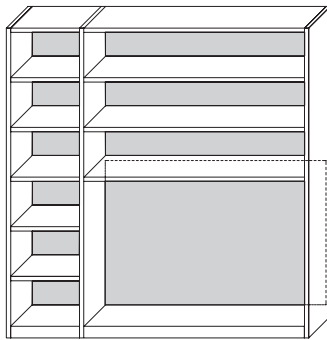

example of Hi-Fi compartment W 1861

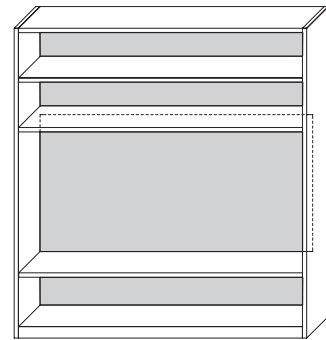

suspended TV compartment

when the TV compartment is inserted in a suspended composition an upper compartment must be provided.

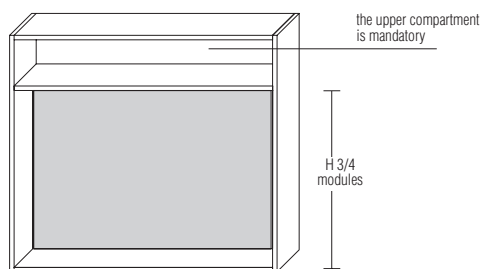

DATASHEET

REGISTERED
DESIGN

VII.2016

molteni.it

Dimensions in millimeters and inches. The right to discontinue and make changes is reserved. This information is based on the latest product information available at the time of printing.

BOISERIE COMPARTMENTS WITH DOUBLE PANELS D 400

Using two modules 1260-1417-1890, it is possible to create boiserie compartments from W 2491 mm to 3751 mm. The boiserie compartment is always fitted with two removable backs on which it is possible to mount the TV

For wall-mounted TV, the wiring hole on the back is the client's responsibility. The back is fastened frontally. The structural shell **must have the bar** even if it is fastened to the wall or if the composition is suspended. The two backs are joined in the centre with a central support joint for the panels.

The back height is lower than the compartment height to allow passage of wiring from the air space to the TV compartment.

TV signal receiver

The \varnothing 18 sensor is always positioned in the lower part of the TV back. Specify right or left when ordering. IR bars can only be placed in a compartment adjacent or below the TV back (to be specified when ordering). The cost of a wire passage is not included. The bar can only be fixed to the structural panels.

Wire passage

The Hi-Fi compartment may be connected using a wire passage to adjacent or lower compartments. The wire passage is located behind the TV back.

Molteni & C

Compartments with double boiserie panels

It is obligatory to have a compartment above and below the boiserie compartment with double panels.

Also, the width of the upper and lower shelves **A** must correspond to the panel width.

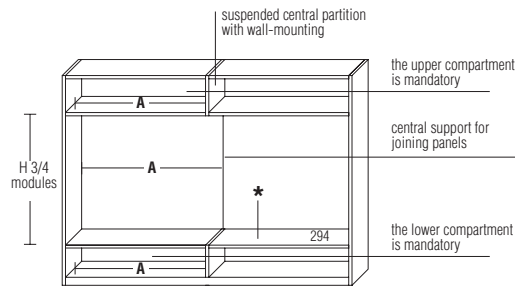

* The lower part of the boiserie panel must always be finished with a wood top th 10 or with a protruding top D 540 H 72

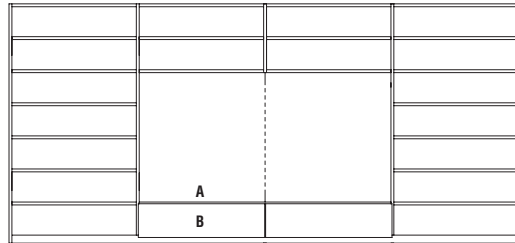

- A** - The wood top th 10 is always the same dimensions as the boiserie compartment
- B** - The compartment can be closed with a flap door or drawers

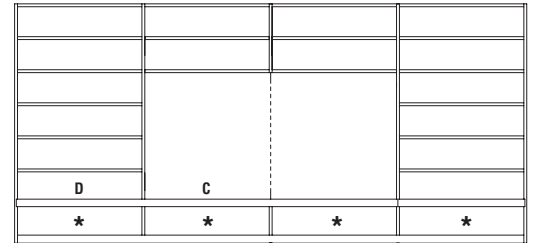

- C** - The protruding top can span more than one compartment of the composition
- D** - The compartment above the protruding top cannot hold mobile dividers or partitions th 28. If W 1417-1890 always with the back
- * Compartments always open. If W 1417-1890 always with the back

DATASHEET

REGISTERED
DESIGN

VII.2016

molteni.it

VERTICAL SLIDING DOORS TH 40

The units in 505 compositions W 1260-1417 can be closed with vertical sliding doors for H 2 modules. Lower and upper shelves must be structural aluminium shelves and interrupt the back. The vertical sliding door cannot be used in units D 304 mm. For the movement of the vertical sliding door, the upper 2 compartments must remain open. The vertical sliding mechanism is completely contained in the compartment for H 2 or H 3 modules if paired with a flap door.
Two vertical sliding doors can be used side by side.
The vertical sliding door can close on a D 540 H 72 protruding shelf

Notes

The price of the vertical sliding elements includes the tracks attached to the sides.
Upon request, at no extra charge, the vertical sliding door can be created with a type "B" handle fixed centrally at the bottom.

* wood only with horizontal grain

Molteni & C

10—
14

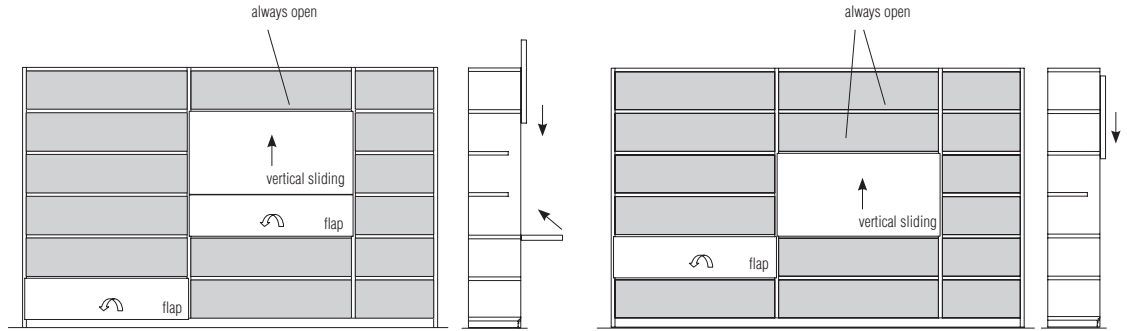

Deluxe Interior

Version with vertical sliding door + flap door accessorised with:

- 2 bronze mirrors
- Shelf covered in Eco Skin in the 5 colours of the Molteni Range with electrical outlet and USB charger
- Lighting system with 3 LED lights with switch

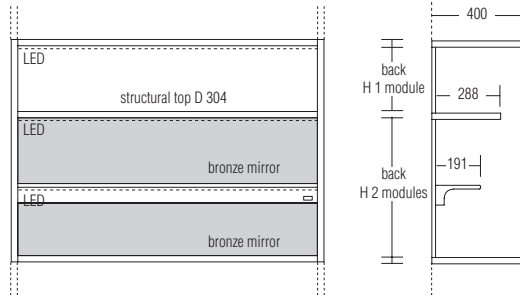

Version with vertical sliding door accessorised with:

- 2 bronze mirrors
- Shelf covered in Eco Skin in the 5 colours of the Molteni Range with electrical outlet and USB charger
- Lighting system with 2 LED lights with switch

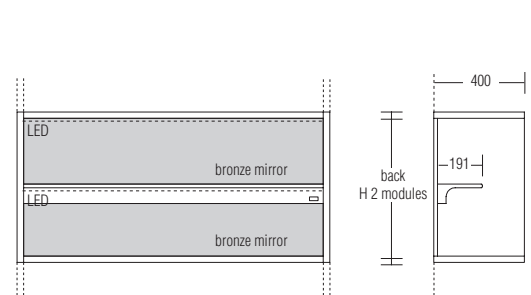

Standard interior

Version with vertical sliding door + flap door

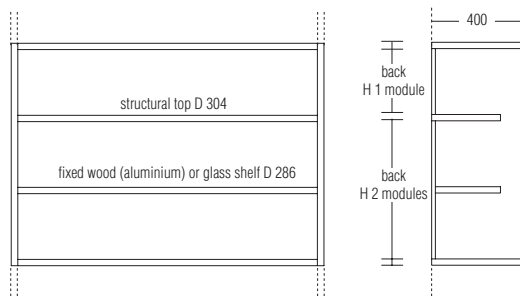

Version with vertical sliding door

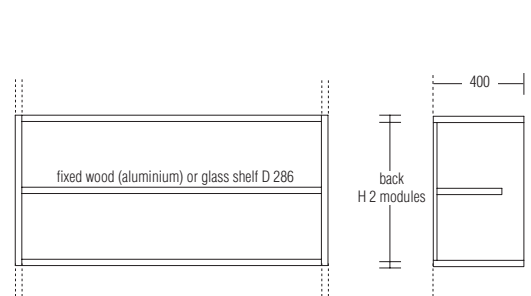

DATASHEET

REGISTERED
DESIGN

VII.2016

molteni.it

Dimensions in millimeters and inches. The right to discontinue and make changes is reserved. This information is based on the latest product information available at the time of printing.

PROTRUDING SHELVES D 540 H 72

It is possible to use protruding tops only in compositions with D 400.

In the floor-standing compositions, the protruding top can be positioned at the height of 1 or 2 modules, in the suspended compositions it can be on the base.

Protruding shelves are set on structural tops th. 28 and the back must be interrupted, or on the specifically designed brackets for wall-mounting (**drawing 1**).

The compartment above the protruding top must always have a back, TV panels or boiserie panels. It can be closed only with a vertical sliding door.

The compartment below the protruding top is always open.
In modules of widths 1417 and 1890, compartments under the protruding top must always have backs.

It is possible to make protruding tops in a single piece up to mm 3775 (two modules of W 1890).
For longer protruding tops, the joint must be done in correspondence with a partition piece (see detail of **drawing 5**).

Tops can be reduced in width when they are independent (**drawing 4**) or for the external part of the composition (**drawing 3**).
Cutting to measure is included in the price.

The client is responsible for the cost of fastening the brackets to the wall, which must be done correctly, on walls in masonry suitable for withstanding the weight and load of the top.

The price of the fixing brackets is not included in the price of the protruding top.
The quantity of the brackets to use for independent tops or tops on the external parts of compositions is indicated in the price list with the corresponding measurements.

The **EPA3** wire holder can be applied in the central position respect to the lower compartment. If there is an external top to the composition, it will be centred with respect to the protruding measurement.

If the top is in Eco Skin, the wire holder will be provided in matt lacquer in a corresponding colour.

Shelf wood finishes

eucalyptus
grey oak
graphite oak

Shelf special wood finishes

light elm
dark elm

Shelf Eco Skin finishes

grey
mink
hemp
ivory
dark brown

Shelf edging finishes

matt lacquer colours in the Molteni
colour range
pewter colour painted

Drawing 1 - Construction diagram

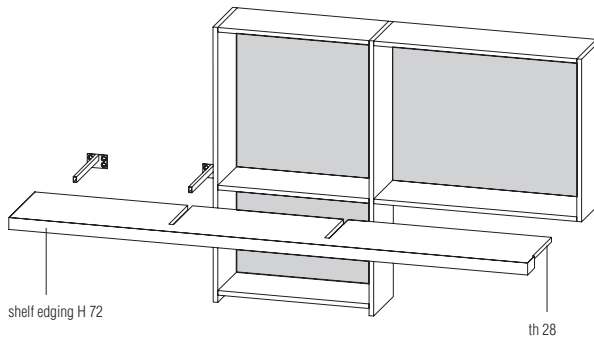

Drawing 2

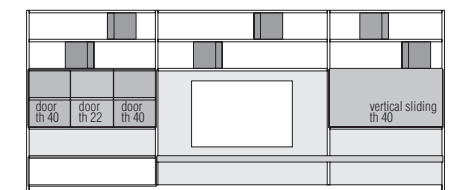

Drawing 3

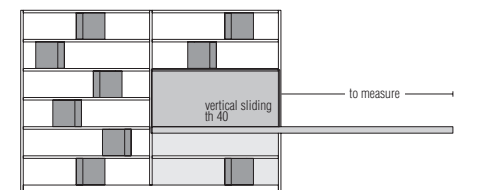

Drawing 4

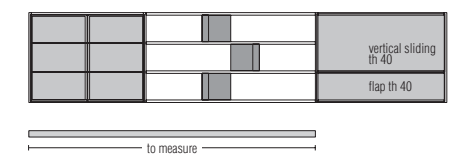

Drawing 5

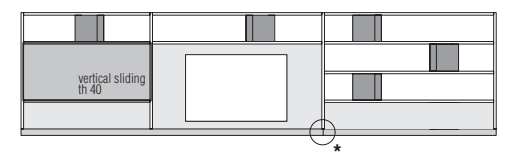

DATASHEET

REGISTERED
DESIGN

VII.2016

DOORS

**pressure
and sliding opening th 40**

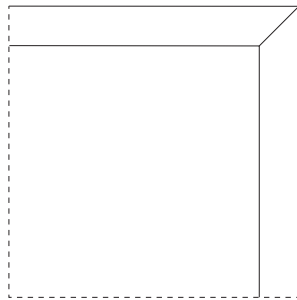

**pressure opening
th 22**

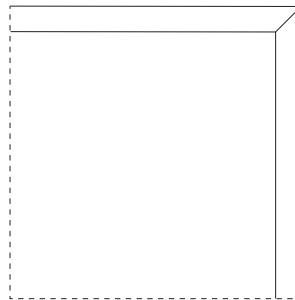

**glass door with
shaped profile**

hinged and sliding doors

this handle is not available
for external drawers

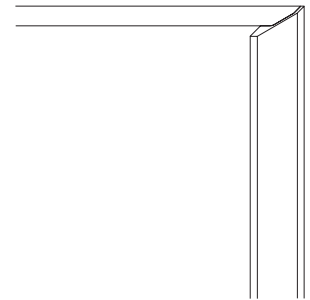

**opening with the handle
th 22**

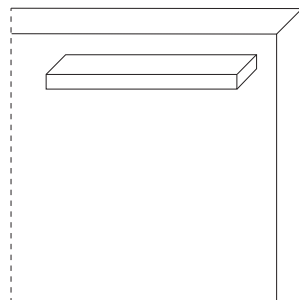

EXTERNAL DRAWERS

Standard version comes with partially extractable runners.
Fully extractable runners are available with a surcharge.

* wooden drawers only with horizontal grain

Notes

External drawers can be inserted into compartments with a height of 1 or 2 modules. A back panel of 16 mm th. and a pair of sides listed below must be added.

Drawers placed on the base

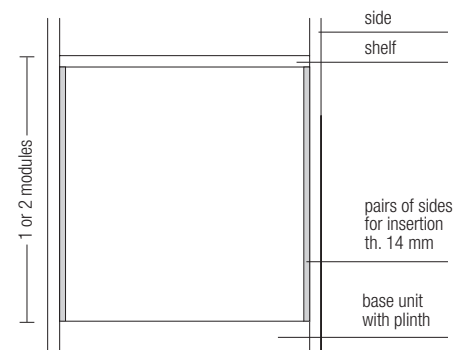

Drawers within the unit

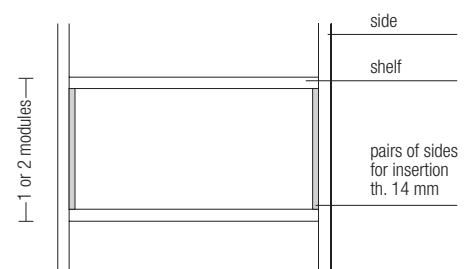

DATASHEET

REGISTERED
DESIGN

VII.2016

molteni.it

Dimensions in millimeters and inches. The right to discontinue and make changes is reserved. This information is based on the latest product information available at the time of printing.

SAMPLE COMPOSITIONS

Bookshelves

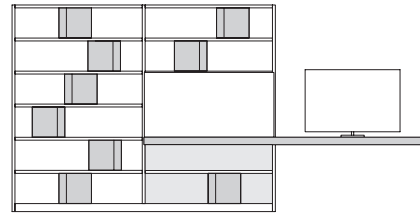
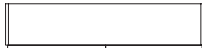
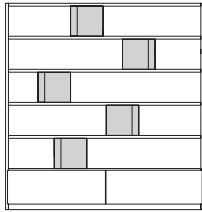
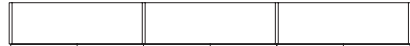
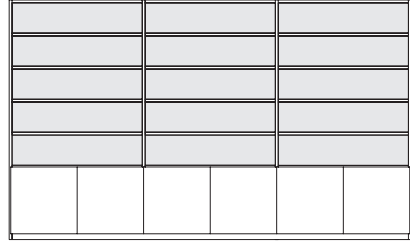
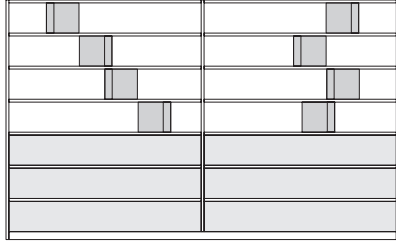

TV compartments

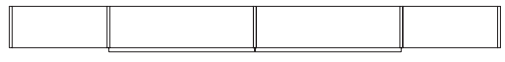
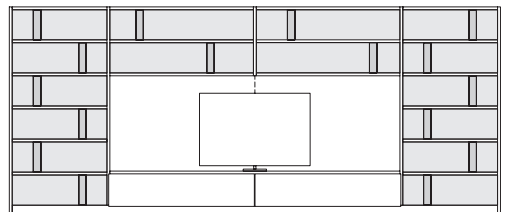
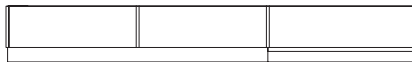
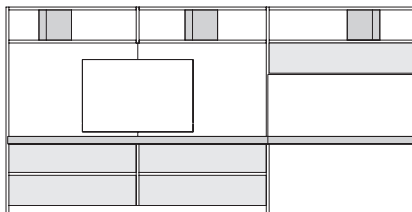
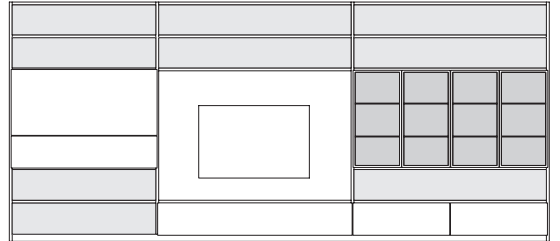
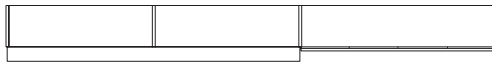
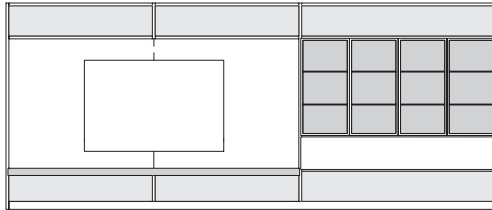

Molteni & C

13 —
14

DATASHEET

REGISTERED
DESIGN

VII.2016

molteni.it

Dimensions in millimeters and inches. The right to discontinue and make changes is reserved. This information is based on the latest product information available at the time of printing.

SAMPLE COMPOSITIONS

Storage or service elements

Molteni & C

14—
14

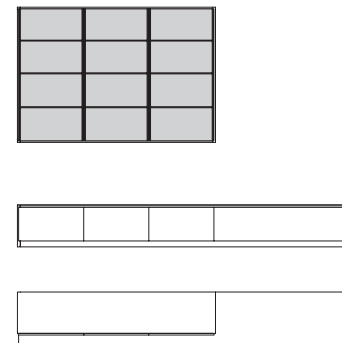
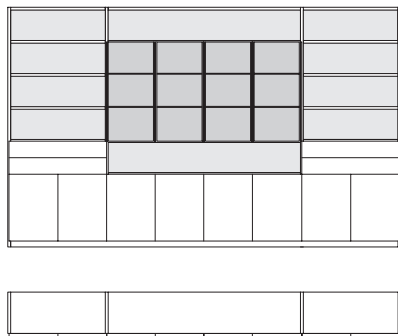
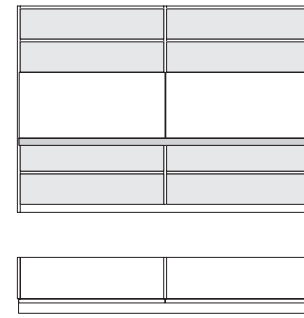
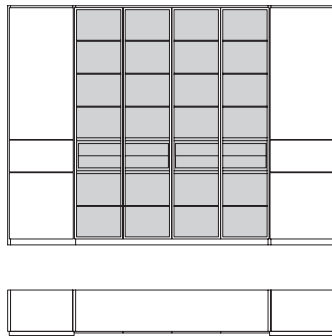
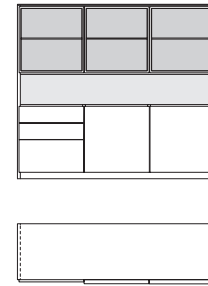
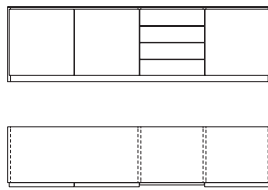
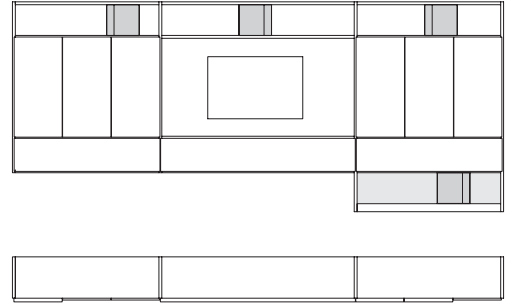
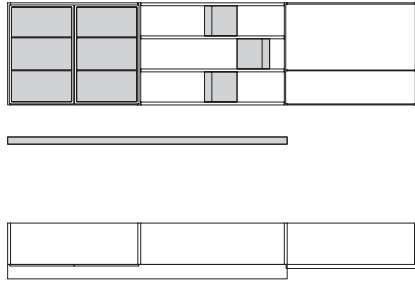

DATASHEET

REGISTERED
DESIGN

VII.2016

molteni.it

Dimensions in millimeters and inches. The right to discontinue and make changes is reserved. This information is based on the latest product information available at the time of printing.

Molteni & C

FINISHES MOLTENI&C RANGE

IX.2016

	MATT LACQUER OPEN GRAIN LACQUER	GLOSSY LACQUER	COLOURED GLASS	ETCHED COLOURED GLASS	PLASTER LACQUERED CARTAPAGLIA LACQUERED <i>only Gliss Master</i>	STOPSOL
CHALK WHITE	•	•	•	•	•	
IVORY	•				•	
PEARL	•	•	•	•	•	
SILICA	•	•	•	•	•	
SAND	•	•	•	•	•	
PLATINUM	•	•	•	•	•	
DUNE	•	•	•	•	•	
CLAY	•	•	•	•	•	
DOLOMITE GREY	•	•	•	•	•	
RUBY	•	•	•	•	•	
CARAMEL	•	•	•	•	•	
MOKA	•	•	•	•	•	
MUSTARD	•	•	•	•	•	
CADMIUM	•	•	•	•	•	
LIGHT BLUE GREY	•	•	•	•	•	
BALTIC GREEN	•	•	•	•	•	
LEAD	•	•	•	•	•	
ANTHRACITE	•	•	•	•	•	
BLACK	•	•	•	•	•	
BRONZE				•		
GREY						•
LESSLESS RED <i>only matt lacquer</i>	•					

Molteni & C

FINISHES MOLTENI&C RANGE

IX.2016

WOODS

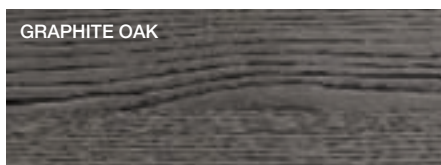
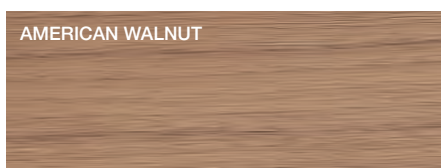
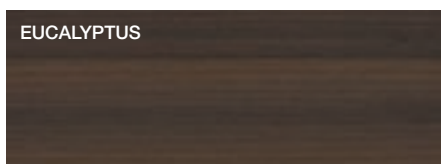

MARBLES

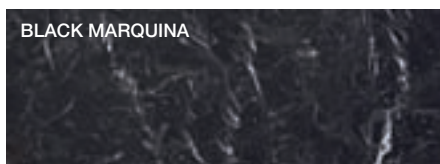
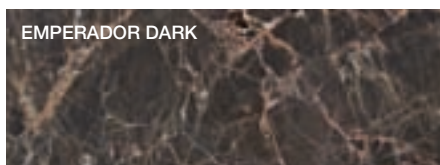
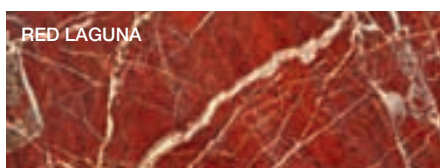
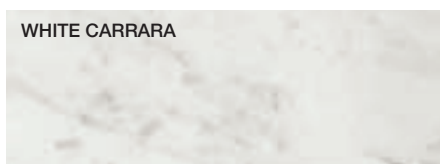

GRES

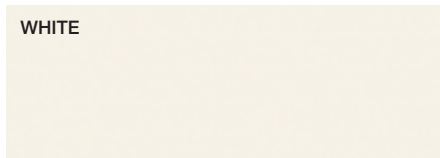

METAL PARTS

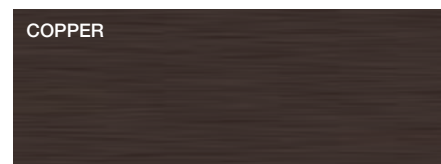
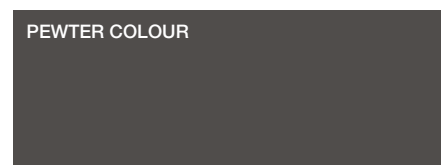
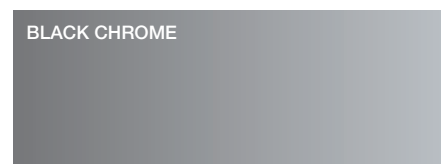

DWELL
DOOR FRAME, TRACK COVERING PROFILES

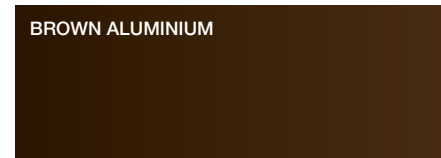

The finishes shown are indicative and refer to the entire production range. We recommend that you consult the "Colour Range" samples which shown the complete range of finishes, including those not shown here. Molteni&C reserves the right to modify the range without warning.

Molteni & C

FINISHES MOLTENI&C RANGE

IX.2016

CARTAPAGLIA

GLISS MASTER, GLISS WALK-IN FRONT

WHITE



ANTHRACITE



CARTAPAGLIA

GLISS MASTER FRONT

SILICA



PLASTER

GLISS MASTER FRONT

SILICA



MILLERIGHE

GLISS MASTER, GLISS WALK-IN STRUCTURE

DARK



MELAMINE STRUCTURE

GLISS MASTER, GLISS WALK-IN

WHITE SHANTUNG

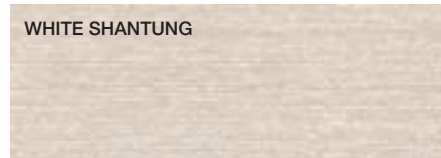

GREY SHANTUNG

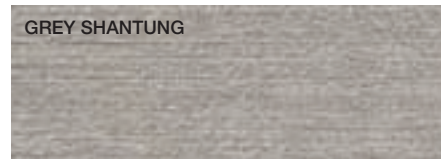

SILVER CEMBRAN

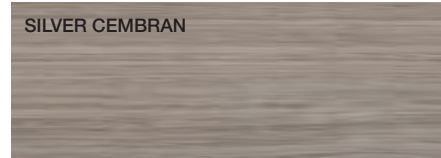

LARIX DARK



ECO SKIN

IVORY



HEMP



MINK



DARK BROWN



GREY

